

BRUSH PANEL INSTALLATION INSTRUCTIONS PLEASE READ

1 Important Notes

Brustics Brushwood Panels are designed and manufactured to suit a wide variety of applications. As with erecting any form of fence a certain level of knowledge, fitness and common sense is required. Correct installation ensures the brush panels' durability. Common installation mistakes are beading the bottom of the panels which creates a water trough for the panels to sit in and not fitting a 150x50mm plinth on edge to support the panels. It is also best to cap the panels to prevent water from softening the top of the panels which typically results in the top thinning out in around 7-10 years. It is the installer's responsibility to ensure they have the necessary skills to carry out the installation and the panels are suitable for the intended application. Should you have questions, or are in the Auckland area and want a quote for installation please call 080 027 8784

2 Items you may require include:

- | | | | |
|---|---|----|---|
| 1 | Post Hole Borer (or Spade) | 6 | Pilers |
| 2 | Spot Welder (if using steel framing) | 7 | Level |
| 3 | Saw/Hacksaw for cutting posts/rails | 8 | Wheelbarrow (somewhere to mix concrete) |
| 4 | Skillsaw - If cutting panels Horizontally | 9 | Hammer |
| 5 | Side Cutters - long handle if available | 10 | Loppers (Secateurs) |

3 General Notes and Tips for Installation

- Check the boundary alignment and ensure that services will not be damaged when digging post holes. Erect a string line and clear the site before commencing installation..
- The Distance between the posts should span no more than two panel's widths; for border style space posts at 2230mm between posts. This allows some clearance to fit the panels. (The end wires of the panel can always be opened out if the clearance is found to be too great).
- For ease of handing, keep panels dry prior to installation.

Cutting Panels Vertically

Cut the top and bottom horizontal wires at the required width + 20 mm. Lay a straight edge down the panel and cut all the wires down the panel at the same width turning back the wires on both sides to prevent brush escaping. Reverse the panel and bend it back at the line of the cut wires. This indicates where the back wires should be cut, repeat the process of cutting and bending back as above.

Cutting Panels Horizontally

Lay the panel on a firm base and accurately draw a line across the panel (we find a blue felt tip permanent marker works best). Cut along the line with a sharp 9 ¼ inch circular saw (spraying silicon on the blade will make the cutting much easier). Adjust the depth of blade no deeper than necessary to reduce drag (wear goggles and gloves). Put the trimmed end to the top.

Joining Panels

After fixing the panels in position, remove the edge links from both panels where they join, straighten and re-loop wires to each other. If wires are a little short, grip the wire with pliers and tap sideways (Snip off extra wire for neatness). Move the brush together to fill gaps. (use a screw driver)



In all cases **panels must be supported clear of the ground by a plinth** (normally 150mm x 50mm H4 timber on its edge), fixed to the posts. If an adjoining garden is to be raised, the plinth can be deeper or raised

Where the ground is sloping, the panels can be racked to suit up to a 1 in 12 fall. If the fall is greater, the fence will need to be stepped, extreme care needs to be taken with measurements when stepping a fence.

Racking Panels and Corners

Hold the panel upright and a little off level. Drop from a few inches on to a solid flat surface. Repeat till correct angle is attained. Note it is easier to rack the panels when they are dry.

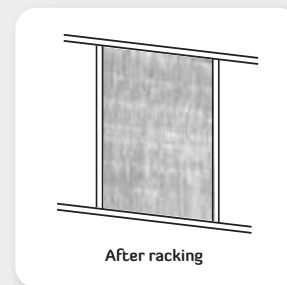
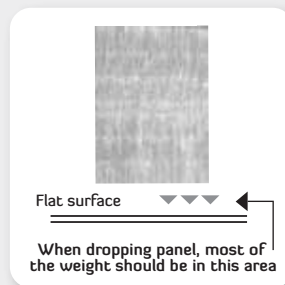
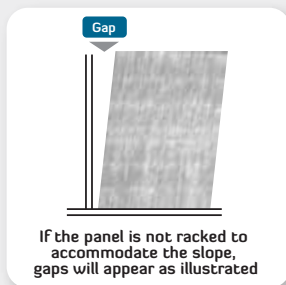

Where the fence line changes direction it is possible to bend the panels up to 45°. This is done by cutting the panel wires on the inside corner and removing a little brushwood. This looks better than cutting and joining panels.

Brush Capping

Curve the wires to create a rounded appearance.



As Purchased



As Installed

4 Brustics Brushwood Fence Panels - Standard Style

(65mm Staples or Tech-screws required)

Diagram A Standard Style

Bottom Placement and Fittings

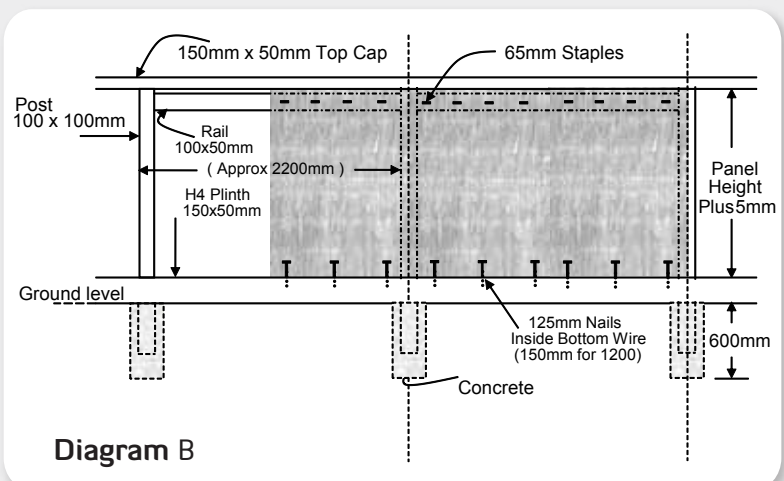
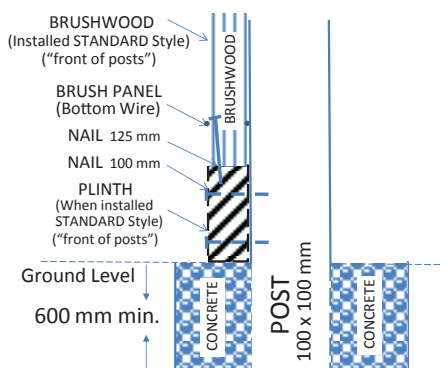

Diagram B

- 1 Measure, mark out and check the intended fence line.
- 2 Dig the post holes 200mm in diameter and 600mm deep: at approximately 2.2m centres. Set the end posts back approximately 75mm from the end point of the fence and the pinth i.e. the plinth and panels can carry past the end post 75mm. Where the slope is greater than 1 in 13, it necessitates stepping the fence and the first post spacing should be 900mm or 2000mm centre to centre and thereafter 1100mm or 2200mm, (i.e. 1 or 2 panel widths)
- 3 Brace the end posts plum and stretch plumb lines tight top and bottom to align the intermediate posts. Set all posts plumb in concrete.
- 4 Timber plinth (**Diag A**) is fitted with 100mm nails to the face of the posts when the concrete has hardened, just above or on the ground line. The plinth should be straight or following the general lie of land. N.B. consider the appearance of the top of the fence line - this will be parallel to the plinth line.
- 5 Top rail 100mm x 50mm H3 is be nailed on edge between the posts and flush with the front and top of the posts – this allows the 150x50mm top cap to be nailed to the top of the rail and posts to reduce twisting; or if intending to fit brush roll caps, leave at least 120mm below the top of the panel and the framework to allow for the addition of roll-caps. Where high winds are experienced a bottom rail is recommended, approximately 200mm above the plinth.
- 6 Place the first panel on the plinth, check for plumb, staple or tech-screw (**Diag B**) through the panel (not over the horizontal panel wire) into the rail(s).
- 7 Place the second and subsequent panels on the plinth and fix in same way. Check panels for plumb as proceeding. Tie together (see notes).
- 8 Where a bottom rail is not used, fix the bottom of the panels by driving 125mm galv nails (150mm galv nails for 1200 panels) (**Diag A or B**) into the plinth behind the bottom panel wire. This prevents the panels from slipping off the plinth.

5 Fitting Brustics Brushwood Fence Panels to an Existing Frame or Fence

- Ensure all posts and rails are sound and replace where necessary.
- Follow instructions 4-10 of "Standard style". Existing rails may need packing out to be flush with the posts.
- As an alternative; panels can also be made to look as though installed border style as per the photos **before and after below**.

Before



After



25mm x 25 mm bead required

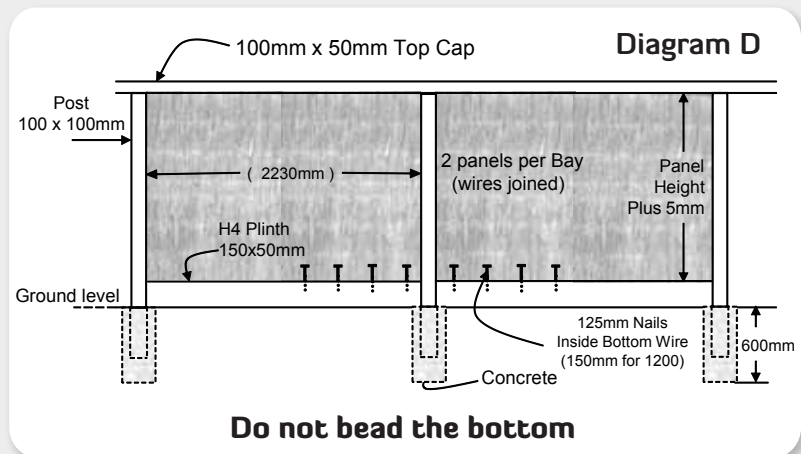
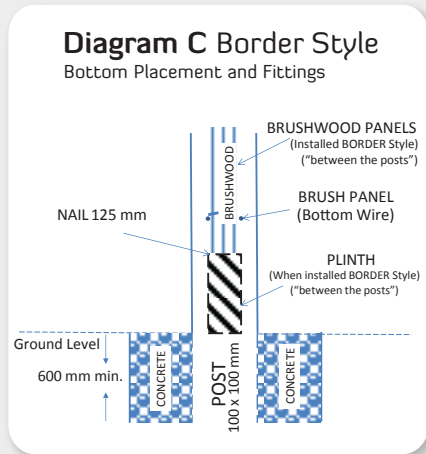

- 1 Mark out and measure the intended fence line (See Important notes first page).
- 2 Dig post holes 200mm in diameter and 600mm deep. Spacing between the posts must be exactly 2.23m or 1.115m, i.e. 2 or 1 panel widths (this allows clearance for easier installation - the end wires can be opened out if the clearance is found to be too great). As you dig post holes, place posts in the hole and check the distance between using a 2.23m or 1.115m spacer. Corner posts need to be 100mm x 100mm - other posts can be 100mm x 75mm if required.
- 3 Brace end posts plumb and stretch lines tight, top and bottom, to align intermediate posts. Plumb these and set in concrete.
- 4 When concrete has hardened, fix H4 plinth (Diag C) between and in the centre of posts at ground line, level, or following lie of land. N.B. When fixing plinth consider appearance of top of fence line. This will be parallel to plinth line.
- 5 Cut top of posts parallel to plinth at panel height plus 5mm.
- 6 Nail capping (100mm x 50mm H3 - we recommend bevelling the edges to enhance appearance) on top of posts ensuring correct distance between. (2230mm measured horizontally).
- 7 Using 50mm nails, nail 25mm x 25mm bead to rear of inside of posts and underside of capping.
- 8 Place panels on plinth and against beads (if a tight fit a flat bar or wide chisel may be used to lever centre together).
- 9 Nail second set of beads to hold panels in place.
- 10 Fix the bottom of the panels by driving 125mm (150mm for 1200's) galv. nails (see diagram D) into the plinth and wire to bottom panel wire. This prevents the panels from slipping off the plinth. It is easier to place wire in position before driving nails.
- 11 Tie the panels together (See Note Joining panels second page)